

# User's Guide

**RF Lesion generator for tissue  
ablation during surgical procedures  
with  
Coagulation Electrode  
(ST-UM-15E Rev.9)**

Only the certified medical doctors, capable of conducting surgical treatment using special techniques should use the described equipment in this user's guide. The purpose of this user's guide is to present the way to use the radiofrequency lesion generator and the electrode of STARmed.

**Caution**

This product can be sold only to the medical professional or based only on their request in accordance to the Medical Devices Law.

**Equipment covered in this manual**

Radiofrequency (RF) Lesion generator for tissue ablation during surgical procedures with coagulation electrode.

**Part No.**

**Effective date** 25<sup>th</sup> November 2019

**Notices**

No part of this document may be reproduced, stored in a retrieval system, or transmitted, in any form or by any means-electronic, mechanical photocopying, recording, or otherwise-without written consent of STARmed. Additional copies of this document can be provided if requested.

**EC Authorised Representative**

EMERGO EUROPE

Prinsessegracht 20 2514 AP The Hague The Netherlands

 Device is compliant with the European Communities council directive 2007/47/EC, medical device directive.

**Manufactured by:**

STARmed Co., Ltd.

(Jungsan-dong, Daebang-Triplaon Business Tower), B-dong, 4F & 12F, 158, Haneulmaeul-ro, Ilsandong-gu, Goyang-si, Gyeonggi-do, Korea

TEL: +82(506)-816-3546

FAX: +82(506)-816-4546

**website**

[www.STARmed4U.com](http://www.STARmed4U.com)

## Product warranty

Warranty is for one year.

The company will repair this product for free during the warranty period, one year from the date of purchase, when there is malfunction or product defect that may have been a result of normal transportation and use.

Repair is charged in the following cases.

- Malfunction resulting from natural calamity such as fire, earthquake, fall etc.
- Malfunction resulting from inappropriate move of the product and user's negligent use after installation
- Malfunction resulting from unlawful renovation or repair
- Defect or malfunction occurring after the warranty period expires
- Malfunction resulting when user neglects the warning specified in this user's guide
- Replacement of consumable parts such as battery due to inevitable wear and tear resulting from use

## Safety warning

**Danger**

Indication of the hazardous situation that could result in death, serious injury, or permanent impairment.

**Warning**

Indication of the hazardous situation that could result in minor or moderate harm to a body structure.

**Caution**

Precaution that describes an unsafe situation that could cause equipment damage or product malfunction.

**Important**

Information on the proper use, storage, and maintenance of the product.

Product warranty.....	iii
Safety warning.....	iv
<b>1. System overview.....</b>	<b>1</b>
<b>Caution for electric safety.....</b>	<b>2</b>
Radiofrequency lesion generator.....	2
Peristaltic pump.....	2
<b>Caution for general safety.....</b>	<b>3</b>
Radiofrequency lesion generator with coagulation electrodes.....	3
Grounding pads.....	4
Coagulation Electrode.....	5
Surgical treatment cautions.....	6
Intended use.....	6
Contraindications.....	6
Complications.....	6
Intended PATIENT population.....	6
Intended USER PROFILE.....	7
Intended conditions of use.....	7
Operating principle.....	7
Essential Performance.....	7
System description.....	8
Applied part.....	8
Components.....	8
EMC Information.....	9
Preparations before use.....	10
Radiofrequency lesion generator.....	10
Peristaltic pump.....	10
Electrode tubing set connection.....	10
Grounding pads inspection.....	10
Checking RF electrode and tubing set.....	11
<b>2. Radiofrequency lesion generator.....</b>	<b>13</b>
Description of generator's front panel.....	14
Description of generator's rear panel.....	15
Description of generator's side panel.....	16
Main screen.....	17
Usage 19	
(1) AUTO Mode.....	19
(2) GENERAL Mode.....	20
(3) CONTINUANCE Mode(TRACK ABLATION).....	21
(4) TEMPERATURE Mode.....	22

<b>(5) Measuring Impedance</b> .....	23
<b>A. Operation and storage of PC linked monitor program</b> .....	24
<b>B. Installing and running of monitoring software on tablet PC (VIVALogger)</b> .....	29
<b>C. Foot switch installation and operations guide</b> .....	31
<b>Labeling &amp; Packaging</b> .....	34
<b>Labeling</b> .....	34
<b>Packaging</b> .....	34
<b>Explanation of symbols</b> .....	35
<b>RF generator</b> .....	35
<b>Box</b> 36	
<b>Generator output power characterization</b> .....	37
<b>Diagram of power output data</b> .....	38
<b>Radiofrequency lesion generator specifications</b> .....	39
<b>3. Peristaltic pump</b> .....	40
<b>Description</b> .....	41
<b>Preparations</b> .....	43
<b>Explanation of symbols</b> .....	43
<b>Peristaltic pump specifications</b> .....	44
<b>4. Others</b> .....	45
<b>Device Classification</b> .....	46
<b>Storage and management after use</b> .....	46
<b>Equipment waste and management</b> .....	47
<b>Cleaning and Disinfection</b> .....	47
<b>Maintenance and Service</b> .....	48
<b>Other matters</b> .....	49

# 1. System overview

## Caution

Use this equipment only after reading the warning, cautions and information on the product's usage.

Use other accessories related to this equipment only after reading the warnings, cautions, and information on the product's usage. The user's guide for the electrode is provided separately.

## Caution for electric safety

### Radiofrequency lesion generator

The equipment is designed for the safety and effectiveness of performance, but it is also important how user utilizes the equipment. Read the user's guide before operating the RF Lesion generator and the pump.

#### Caution

User should not disassemble the equipment. Inquire with the STARmed on how to prevent electric shock.

Disconnect the device from the power before cleaning or performing maintenance

Electrical medical equipment requires special precautions regarding EMC. The product needs to be installed according to EMC requirements.

Use of this equipment adjacent to or stacked with other equipment should be avoided because it could result in improper operation. If such use is necessary, this equipment and the other equipment should be observed to verify that they are operating normally.

#### Warning

Do not use on patients with cardiac pacemakers or other active implants.

This equipment outputs energy that can exert physical harm.

This equipment must only be connected to a grounded power supply.

Be cautious not to connect any conductive items to a patient except for grounding pads.

Connect this equipment to a grounded power supply. The user or patient could be injured due to electric shock if a grounded power supply isn't used.

modification of this equipment is not allowed.

Do not use this equipment at a place that is vulnerable to explosion and/or where there is flammable material.

#### Caution

A time interval of approximately five minutes is required (after a coagulation procedure) to stabilize the equipment before the next procedure is started.

Instructions that indicate the output power should be set as low as possible for the intended purpose.

## Peristaltic pump

#### Warning

Stop the pump immediately and remove the power cord if the pump becomes wet.

User should not disassemble the equipment. Inquire with STARmed on how to prevent electric shock.

Do not use this pump at a place that is vulnerable to explosion and/or where there is flammable material.



## Caution for general safety

VIVA combo RF Generator is radiofrequency generator for the cautery of tissue concerning the electrode's tip due to the radiofrequency current. This equipment is safe from electric danger and it has obtained a permit based on the Medical Equipment Law. VIVA combo RF Generator was certified as appropriate by the EN60601-1, EN60601-2-2, EN60601-1-2. This is a Class 1 Type BF medical device.

### warning

The risk of ignition by combustible gas or material at the time of electrosurgery is very high. Thus, if possible, do not place the equipment near combustible materials before the electrosurgery. Avoid using combustible anesthetic drugs, nitrogen oxide, and oxygen on the thorax or head when conducting treatment. Do not place these items near the equipment.

Remove combustible materials used for cleaning and/or removing contaminants before conducting the radiofrequency treatment. Combustible materials remaining on the patient's body could cause a dangerous situation. There is risk of ignition even when the equipment is used normally.

Be careful of the danger of ignition due to the endogenous gas. Materials such as cotton wool and gauze adhere to the oxygen. Thus, there is risk of ignition resulting from flame even when the equipment is used normally.

## Radiofrequency lesion generator with coagulation electrodes

### warning

All electrodes from STARmed Co., Ltd. are recommended for use only with STARmed radiofrequency lesion generators. Please inquire with STARmed on the use of the VIVA, star, and Octopus radiofrequency electrodes.

VIVA combo RF Generator's Maximum output voltage is 275Vp-p. Use the accessories with rated voltage above 275Vp-p.

A warning indicating failure of HF surgical equipment could result in an unintended increase of output power.

### Caution

When fitting the tube into the pump's head, check the exact location after confirming the tube's measurement. Then, secure the tube by pulling on the lever so that the tube will not deviate during use.

Always use the STARmed inflow-outflow tubing set. Use a new tubing set for each patient.

Use only non-flammable agents for cleaning and disinfecting.

Allow any flammable agents used for cleaning or disinfecting to evaporate before the electrosurgery.

Information indicating, there is a risk of pooling of flammable solutions under the patient or in body depressions such as the umbilicus, and in body cavities such as the vagina

### warning

When radiofrequency output is suspected, even after the button on the front panel or foot switch is pressed to stop the radiofrequency output, press the main power switch located on the equipment's rear panel immediately to stop the power. Then, remove the electrode's connector from the RF generator. Stop using the equipment and request service.

Use this equipment only at a place where emergency electric power is supplied, or use it with an UPS (Uninterruptible Power Supply) to prepare for the risk of power failure while operating the equipment.

RF communications equipment (including peripherals such as antenna cables and external antennas) should not be used within 30 cm (12 inches) of any part

of the VCS10, including cables specified by STARMED. Otherwise, this could result in performance degradation.

### Caution

There may be a defect with the grounding pads or electrode cable connection if the radiofrequency output comes out too low or when the output does not come out after starting the electrosurgery. Do not increase the radiofrequency output before identifying the root cause. Confirm that the grounding pads are attached to the patient's skin correctly after a patient moves or changes posture.

The radiofrequency lesion generator and pump may cause electromagnetic wave obstruction in other equipment even when it is operating normally. Place the other equipment as far away as possible if electromagnetic wave obstruction is generated.

Electrodes and probes used for monitoring and imaging can disrupt the radiofrequency current. To avoid unintentional burns, place all other electrodes and probes as far away as possible from the grounding pads and the area to be treated. The use of needle injected monitoring electrodes is prohibited.

It is possible that noise beyond the guaranteed immunity requirements of IEC 60601-1-2, such as any radiofrequency transmitting equipment and/or other sources of electrical noise, can result in disruption of the device's operation.

It is recommended to use monitoring systems that incorporate high frequency current-limiting devices.

It is recommended to position a patient in such a way that contact with the patient or other leads is avoided.

Recommendation to, temporarily, store unused active electrodes in a location isolated from patient

Instructions stating, use of bipolar techniques may be desirable in order to avoid unwanted tissue damage for surgical procedures where HF current could flow through relatively small cross-sectional area of body.

Foot switch operation type is non-continuance activation and press the switch for more than 1 second to start the RF output. Refer to foot switch operation guide.

The EMISSIONS characteristics of this equipment make it suitable for use in industrial areas and hospitals (CISPR 11 class A). If it is used in a residential environment (for which CISPR 11 class B is normally required) this equipment might not offer adequate protection to radio-frequency communication services. The user might need to take mitigation measures, such as relocating or re-orienting the equipment.

## Grounding pads

### warning

Attaching the Grounding pads correctly at the appropriate part is crucial for the safe and effective use of this equipment, as well as to avoid grounding pad burns. Read the Instruction for Use (IFU) that is included with all electrodes from STARmed Co., Ltd for the correct grounding pad usage. The IFU includes the information on the preparation of the grounding pads, location for attachment, inspection, and removal.

When using a single electrode, attach two grounding pads. It is necessary to attach four grounding pads when using multi electrodes. The radiofrequency current gets distributed more evenly when the grounding pads are attached to a wider area. This can also help prevent heat generation within the pad. The distance between each attached pad and cautery lesion should be made as equal as possible to prevent burning.

Be careful not to overheat the grounding pads during ablation.

Avoid air bubbles by carefully attach the grounding pads completely onto a patient. Remove body hair from the grounding pad area if necessary.

To prevent the incident burn due to the contact between patient's skin and skin, place gauze pad in the part where there is contact between the skin and skin in an appropriate manner.

## Coagulation Electrode

### warning

Use caution after removing the electrode from the package to avoid contamination. Avoid applying excessive force to the electrode to prevent damage before use.

Check whether there is groove or crevice in the electrode's insulation and/or cable before using the electrode. The radiofrequency current may leak out if there is an insulation defect. This means that the amount of current that flows at the electrode's tip can decrease, and there is high possibility that burning may result in an unintended area.

The measurement of the body's temperature through the electrode may be inaccurate even when the pump is turned off. The coolant's temperature is bound to decrease due to the circulation when the pump is being operated.

When using the CONTINUANCE mode, adjust the settings so that the stable performance is maintained, and that the radiofrequency output can increase slowly.

### Caution

Conduct periodical performance and safety tests for the reusable cables and accessories.

**Note:** Problem may result when the supplementary accessories are used once.

**Note:** Conduct periodical test of the accessories at all times, and record the results.

## Surgical treatment cautions

### warning

A standard biopsy procedure is required to place the coagulation electrode to the part that is subject to cautery.

It is necessary to use diagnostic imaging to predicate the necrotic tissue area.

Pre-clinical training is required for the doctors by appropriate literature or education to use the electrode of RF lesion generator for tissue ablation during surgical procedures .

### Caution

The equipment's performance is important to obtain safe and effective coagulation results, but the operator's skill is a significant factor as well. Please read all instructions on how to use the radiofrequency lesion generator and pump. Please provide this user's guide to operating and/or maintenance users.

### Important

If the VIVA combo RF generator is affected by an electrostatic discharge(ESD) or power surge, the PC connection may get disconnected. If that happens, the PC linked program should be connected again.

The electrode should only be used with STARmed Co., Ltd. products.

## Intended use

RF Lesion generator for tissue ablation during surgical procedures is intended for coagulation of tissue during percutaneous, laparoscopic, and intraoperative surgical procedures.

## Contraindications

The RF Lesion generator for tissue ablation during surgical procedures is contraindicated for use in patients with Implantable Pacemakers and Automatic Implantable Cardioverter/Defibrillators (AICDs), as they may be adversely affected by radiofrequency (RF) current.

## Complications

The following types of complications may result due to the use of the radiofrequency lesion generator and electrode.

- tumor recurrence
- burn due to the over-heating of the surgical equipment
- dangerous situation due to the unskilled equipment control
- cross-infection or complications due to the re-use of the inappropriate electrode
- ascites/diarrhea
- bleeding of the coagulated part
- ventricular fibrillation

## Intended PATIENT population

- a) Age : newborns to geriatric
- b) Weight : > 2.5kg
- c) Gender : Male and Female
- d) Health: Use for the patient with liver cancer, thyroid cancer, lung cancer, kidney cancer, or other lesions.
- e) Nationality : multiple
- f) Patient's state: The patient is not the device user. Not relevant unless the patient is agitated.

## Intended USER PROFILE

Considerations		Requirement description
Education	Minimum	• Medical doctor who has medical license.
	Maximum	• N/A
Knowledge	Minimum	• Knowledge of the side effect or complications due to the error of medical device. • Clinical expertise with appropriate literature or training
	Maximum	• N/A
Language comprehension	Minimum	• Understand the manual • Understand the meaning of the abbreviation.
	Maximum	• N/A
Experience	Minimum	• Procedure performance and specific technology training • Device usage and safety training
	Maximum	• N/A

## Intended conditions of use

Considerations		Requirement description
Environment	General	<ul style="list-style-type: none"> <li>• Only for professional use</li> <li>• Use at the operating room in the hospital</li> <li>• Keep the accuracy of output when function is operating.</li> <li>• No flammable materials</li> <li>• Connect electrode to peristaltic pump with activating coolant.</li> <li>• Use only after installing the device on a flat surface</li> <li>• An electrode from a different device shall be located far away</li> </ul>
Frequency of use		<ul style="list-style-type: none"> <li>• Use for a maximum of 30 minutes.</li> <li>• The power cycle is 10 seconds on / 30 seconds off.</li> </ul>
Mobility		<ul style="list-style-type: none"> <li>• The device can be transported inside of hospital operating rooms.</li> </ul>

## Operating principle

The RF generator works at 500kHz. The frequency flows to the electrode's tip and then is applied to the tissue. Frictional heat occurs and causes the ions to move from the negative pole to the positive pole and from the positive pole to the negative pole forty to fifty thousand times per second. Tissue necrosis is the principle that occurs by using heat generated from the tissue impedance.

## Essential Performance

Essential performance of this equipment are as followings;

- Accuracy of output control setting
- Monotonicity of output control setting
- Accuracy of maximum output voltage

## System description

The VIVA combo RF system consists of an RF generator, Peristaltic pump, cables, and accessories. This VIVA combo RF Lesion generator is designed to coagulate local tissue through a coagulation electrode.

Radiofrequency power is supplied and controlled with maximum of 200 Watt. Power, impedance, current and temperature are monitored. The temperature of the electrode's tip is monitored for charring.

Power, impedance, current and temperature are stored through a PC software program after connecting the communication terminal of the rear panel of the RF generator with the PC via the communication cable.

## Applied part

Grounding pads, Electrode tip

## Components

1. VIVA combo RF Generator
2. coagulation electrode set (optional: supplied separately)
3. electrode conversion cable (optional)  
- Total Length : 0.28m±10, SPP Series
4. Peristaltic pump
5. foot switch (1 tier: blue) (optional): RF ON/OFF button function  
- Total Length : 4.1m±10, SN Series
6. foot switch (2 tier: blue/yellow) (optional): RF power adjustment function  
- Total Length : 4.1m±10, SN Series
7. power cable  
- Total Length : 1.8m±10
8. USB communication cable  
- Total Length : 1.9m±10, USB A B Type
9. CD (user's guide, PC linked monitor program, USB driver)
10. equipotential earthing cable  
- Total Length : 2.1m±10, MC POAG Series
11. user's guide

### Caution

Use of accessories, transducers and cables other than those specified or provided by the manufacturer of this equipment could result in increased electromagnetic emissions or decreased electromagnetic immunity of this equipment and result in improper operation.

### Caution

Refer to the list of components above for all the cables and maximum lengths of cables, transducers and other ACCESSORIES that are replaceable by the RESPONSIBLE ORGANIZATION and that are likely to affect compliance of the ME. Refer to above list of components.

## EMC Information

Phenomenon	Basic EMC standard or test method	Port tested	Test level/requirement
Mains terminal disturbance voltage	CISPR11:2015	AC Mains	Group2, Class A
Radiated disturbance	CISPR11:2015	Enclosure	Group2, Class A
Harmonic Current Emission	IEC 61000-3-2:2014	AC Mains	Class A
Voltage change, Voltage fluctuations and Flicker Emission	IEC 61000-3-3:2013	AC Mains	Pst: 1 Plt: 0.65 Tmax:0.5 dmax: 4% dc: 3.3%
Electrostatic Discharge Immunity	IEC 61000-4-2:2008	Enclosure	± 8 kV/Contact  ± 2, ± 4, ± 8, ± 15 kV/Air
Radiated RF Electromagnetic Field Immunity	IEC 61000-4-3:2006 A1:2007+A2:2010	Enclosure	3 V/m 80 MHz-2.7 GHz 80% AM at 1 kHz
Immunity to Proximity Fields from RF wireless Communications Equipment	IEC 61000-4-3:2006 A1:2007+A2:2010	Enclosure	Table 9 in IEC 60601-1-2: 2014
Electrical Fast Transient/Burst Immunity	IEC 61000-4-4:2012	AC Mains	± 2 kV, 100 kHz repetition frequency
Surge Immunity	IEC 61000-4-5:2014	AC Mains	Line to Line ± 0.5 kV, ± 1 kV  Line to Ground ± 0.5 kV, ± 1 kV, ± 2 kV
Immunity to Conducted Disturbances Induced by RF fields	IEC 61000-4-6:2013	AC Mains	3 V 0.15-80 MHz
		Sip/Sop  Patient Connected	6 V in ISM bands Between 0.15 MHz and 80 MHz 80% AM at 1 kHz
Power Frequency Magnetic Field Immunity	IEC 61000-4-8:2009	Enclosure	30 A/m 50 Hz & 60 Hz
Voltage dips	IEC 61000-4-11: 2004	AC Mains	0 % $U_i$ ; 0.5 cycle At 0°, 45°, 90°, 135°, 180°, 225°, 270° and 315°
			0 % $U_i$ ; 1 cycle and 70 % $U_i$ ; 25/30 Cycles Single phase: at 0°
Voltage interruptions	IEC 61000-4-11: 2004	AC Mains	0 % $U_i$ ; 250/300 cycle

## Preparations before use

### Radiofrequency lesion generator

1. Check the rated voltage is correct for the equipment before connecting the power .

#### Caution

The equipment may be damaged if it is not connected to the correct voltage.

2. Warning: To avoid risk of electric shock, this equipment must only be connected to a power supply with protective earth.
3. Avoid using the equipment at an unsanitary or flammable place.
4. Power on, Power off Procedure
  - 4-1 Before Surgery
    - 1) Connect the power cable to the RF generator
    - 2) Press the power switch
    - 3) Check the main menu
  - 4-2. After Surgery
    - 1) The output is stopped
    - 2) Press the power switch
    - 3) Disconnect the power cable from the RF Generator

### Peristaltic pump

1. Connect the power cable to the pump's rear part.
2. Warning : to avoid risk of electric shock, this equipment must only be connected to a power supply with protective earth.

### Electrode tubing set connection

Preparation materials:

- Coolant container (3L capacity)
  - Cooled sterilized saline solution bag (1 - 3L)
1. Make sure that the IV bag is sufficiently cooled before the treatment.
  2. Use the saline solution as coolant before the treatment.

**Note:** 2L coolant is appropriate for a 12 minutes-long treatment. The pump's flow rate is appropriately 100ml/min.

3. The coolant temperature is indicated on the generator when the coolant is connected and circulating through the pump. The cooling temperature is normally less than 20°C.

When the cooling temperature is over 25°C, ensure that the coolant's temperature is maintained by placing the IV bag into the coolant's storage container.

### Grounding pads inspection

1. When attaching the grounding pads to the patient's thigh, please make the pads are firmly attached without air bubbles or irregularity.
2. There is a risk of burning when the grounding pads are not completely attached to the patient's thigh. Double-check the location and attachment of the grounding pads.
3. Connect the grounding pads with the ground Plate connector (P9532-EXT). Then, plug the grounding connector to the generator's front panel.



## Checking RF electrode and tubing set

Connect the electrode and the tubing set in the following sequence:

**Note:** Confirm that the power cables for the generator and the pump are connected.

### [VP01]

1. Place the IV bag above the patient and equipment to allow the air in the IV bag to elevate upward.
2. Pull the tube's compression lever indicated in the following photo in a counterclockwise direction.
3. Place the pump's tube in the roller that is located inside of the pump's head. Adjust the tube so that the left and right parts of the tube are similar in length.

**Note:** Check that the coolant's flow direction is set in the correct direction of the pump's head. Check the direction of the arrow on the front of the pump.

4. Pull down the roller head's cover by pushing the tube compression lever to the very end towards the right side up to 180°. Check to make sure the tube is tight and placed correctly.

[Location for the pump diagram]

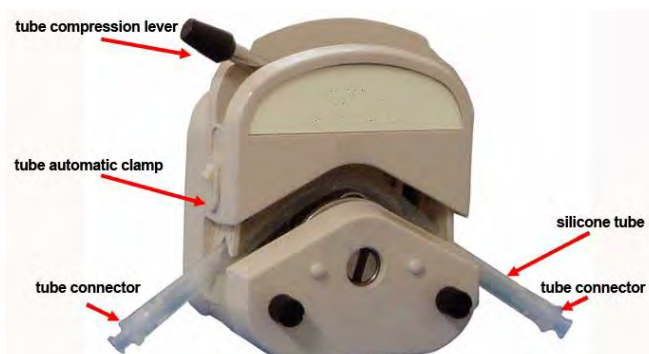

5. Push the input tube's spike into the inside of the saline solution bag while the input tube's roller clamp is temporarily closed.
6. Place the ends of the output tube in the water container after connecting the output tube to the electrode's coolant outflow connector.
7. Open the Input tubing's roller clamp.

**[VP01-1]**

1. The saline solution bag should be located above the equipment and the patient so that the force of gravity helps the solution to flow downward.
2. Flip the cover upwards as indicated in the photo below.
3. Place the pump's tubing in the roller located inside the pump's head. Adjust the tubing so that the length of the tubing is equal on both sides of the pump.

**Note:** Check that the arrow on the pump and tubing is facing the same direction. Check that the coolant flows in the same direction as indicated on the arrow.

4. Flip the cover down and check that the tubing is secure.

[Location for the pump diagram]



5. Push the inflow tubing's spike into the inside of the saline solution bag while the inflow tubing's roller clamp is temporarily closed.
6. Place the end of the outflow tubing in a water container after connecting the outflow tubing to the electrode's coolant outflow connector.
7. Open the inflow tubing's flip cover.

**Warning**

All RF electrodes from STARmed and tubing set are sterilized products for disposable use. Re-sterilization and reuse are prohibited.

Stop using the electrode if the patient's body temperature is not indicated on the screen of the generator after all the preparations are completed, after the electrode is inserted into the human body, and before the radiofrequency ablation starts. After starting the pump, the lowered temperature in combination with the coolant's temperature is displayed.

## 2. Radiofrequency lesion generator

### Caution

Use the equipment only after reading the warnings, cautions, and information on the product's usage.

Use other accessories related to this equipment only after reading the warnings, cautions, and information on the product's usage. The user's guide for the electrode is provided separately.

## Description of generator's front panel

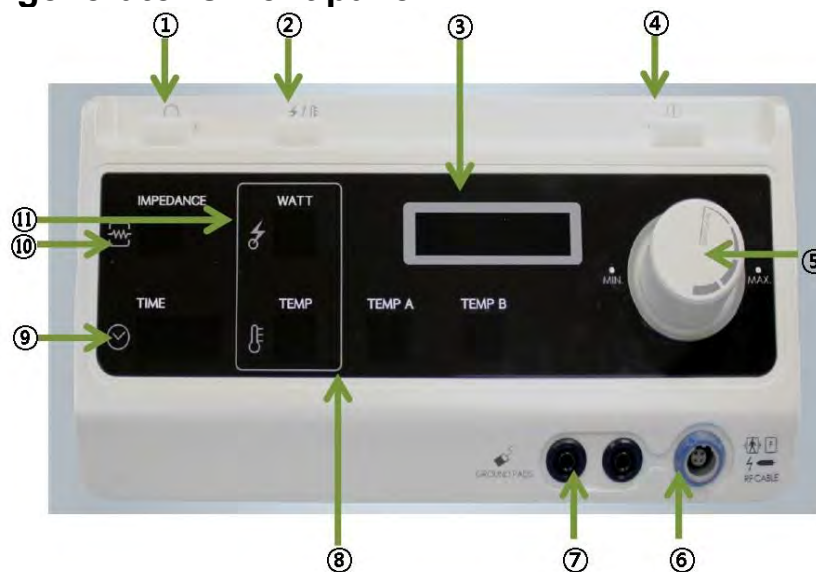

No.	Feature name	Function
1	OHM/RESET button	Measures the impedance of targeted tissue from the active tip.
2	MODE button	Mode selected (General, Continuance, Auto, Temperature) button
3	<u>Digital Display</u>	Indicates the menu setting concerning equipment operation, and indicated status including the power, impedance, temperature, time.) at the time of operation. Refer to the explanation on the Main screen.
4	RF START/STOP button	Pressing this button turns the RF output ON and OFF.
5	RF POWER control dial	Adjusts the RF power output and other settings. (AUTO mode is an exception)
6	RF CABLE connector	These are the electro-surgical electrode couplers for the RF output. The electrode's cable is connected here.
7	GROUND PADS connectors	These are the couplers for the RF current to be released from the RF electrode. The grounding pad's cable is connected here.
8	Display the temperature values	Measures the temperature of targeted tissue from the active tip.
9	TIME	Indicates the lap time for a RF ablation.
10	Display the IMPEDANCE values	Indicates the resistance value of the targeted tissue at the time of RF output.
11	Display the RF POWER values	Indicates the actual amount of radiofrequency power that is supplied to the electrode and targeted tissue.

## Description of generator's rear panel

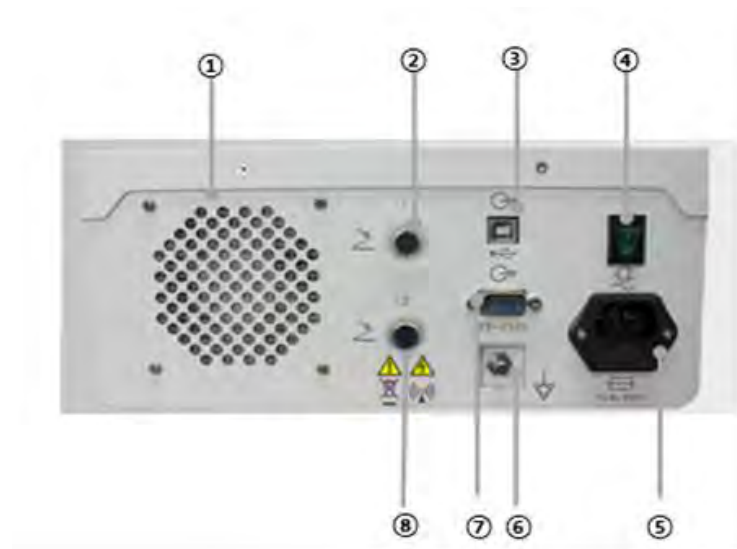

No.	Feature name	Function
1	Ventilation hole	Hole for cooling down the inside of the system
2	Foot switch connector (upper part)	Foot switch pedal connected with this part that offers the same function as that of the RF ON/OFF button function
3	Data Port	Connecting part for the serial communication with PC, and it monitors the generator' operation state (power, current, impedance, temperature, time etc.) from a PC.
4	Power switch	Turns the main power supply on/off
5	<u>Fuse/power socket</u>	Power is supplied to the generator by coming into contact with the power cable. This includes the fuse box where two fuses are connected.
6	<u>Potential equalization terminal</u>	An equi-potential grounding terminal which can be used to connect different pieces of equipment together to maintain equal grounding.
7	RS-232C Data communication connector	Equipped with RS-232 serial communication module to allow the operating conditions such as power, current, impedance, temperature, and time to be monitored on a tablet PC.
8	Foot switch connector (lower part)	Foot switch pedals connected with this part that offer the same function as that of the RF power control dial function. (yellow (-), blue (+))

## Description of generator's side panel

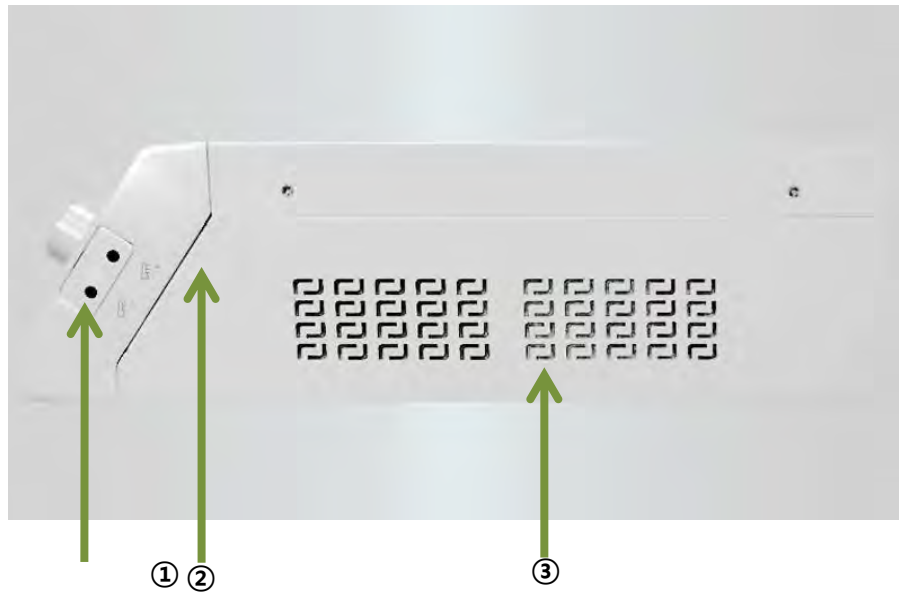

No.	Feature name	Function
1	Temperature sensor connector B	<u>Connector for temperature sensor to measure the temperature of the target area.</u>
2	Temperature sensor connector A	<u>Connector for temperature sensor to measure the temperature of the target area.</u>
3	Ventilation hole	Hole for cooling down the inside of the system

## Main screen

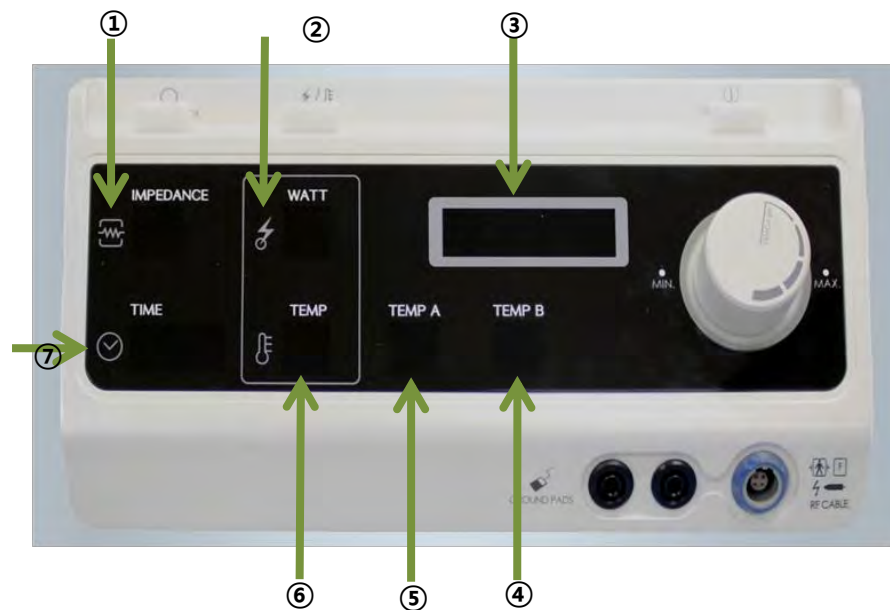

No.	Feature name	Function
1	IMPEDANCE	Indicates the resistance value of the targeted tissue at the time of RF output.
2	RF POWER-LAP	Indicates the actual amount of radiofrequency power that is supplied to the electrode and targeted tissue.
3	MODE	User setting mode is displayed
4	TEMP-B	Temperature measured at the temperature sensor connector B displays the value.
5	TEMP-A	Temperature measured at the temperature sensor connector A displays the value.
6	TEMP	Indicates temperature at the active tip of electrode
7	TIME	Indicates the lap time for a RF ablation.



---

8 System message 1 Indicates message when the resistance value is too high or when the state of grounding pads, electrode connection are faulty

---

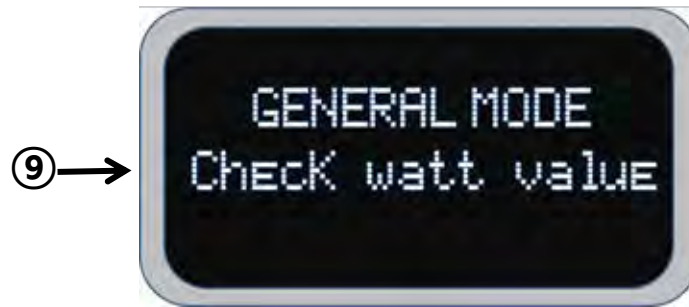

---

9 System message 2 Indicates message when RF output is 0 (General Mode only).

---



---

10 System message 3 Indicates message when the temperature is too high.

---



---

11 System message 4 In temperature mode, in case of not reaching the setting figure, continuing unexpected impedance and coming out power output continuously under the setting temperature, this message appears .

---



## Usage

### (1) AUTO Mode

A) Check the digital display after selecting AUTO Mode by pressing MODE button.



B) Turn the RF POWER Control Dial to set level of RF Power output.



C) The level of RF POWER output can be set from 5W to 100W.

D) The RF POWER output which user set up is generated with light up on RF START/STOP button if it is pressed.



E) RF POWER output, impedance, temperature of electrode and elapsed time will be displayed on VFD, FND screen.

F) The RF POWER output will be increased by 10W in every 1 minute and the RF POWER output is generated in the form of pulsing after Roll-off.

**Note:** The maximum RF POWER output value is 150W.

G) Button's light is automatically off with stopping the RF POWER output after 12 minutes elapsed.

H) Light of the RF START/STOP button will be turned off and the RF POWER output will be stopped by pressing RF START/STOP button even before the 12 minutes elapsed.

## (2) GENERAL Mode

A) Check the digital display after selecting GENERAL Mode by pressing MODE button.



B) Turn the RF POWER Control Dial to set level of WATT.



C) The RF POWER output which user set up is generated with light up on RF START/STOP button if it is pressed.



D) The alarm sounds 3 times in 2 ~ 3 seconds interval after RF POWER output for 12 minutes.

**Note:** the RF POWER output is be generated in the form of pulsing.

**Note:** The RF POWER output value can be adjusted by turning the RF POWER

control dial while in use.

**Note:** Maximum RF POWER output is 150W.

E) RF POWER output, impedance, temperature of electrode and elapsed time will be displayed on VFD, FND screen.

F) RF POWER output is stopped with light off when the RF POWER START/STOP button is pressed while in use.

G) The RF POWER output is restarted from the RF POWER output value the most recently set up if RF START/STOP button is pressed again.

### **(3) CONTINUANCE Mode(TRACK ABLATION)**

A) Check the digital display after selecting CONTINUANCE Mode by pressing MODE button.



B) Turn the RF POWER Control Dial to set level of WATT.



C) The RF POWER output which user set up is generated with light up on RF START/STOP button if it is pressed.



**Note:** The RF POWER output value can be adjusted by turning the RF POWER

control dial while in use

D) RF POWER output, impedance, temperature of electrode and elapsed time will be displayed on VFD, FND screen.

E) RF POWER output is stopped with light off when the RF POWER START/STOP button is pressed while in use.

F) The RF POWER output is restarted from the RF POWER output value the most recently set up if RF START/STOP button is pressed again.

#### **(4) TEMPERATURE Mode**

A) Check the digital display after selecting TEMPERATURE Mode by pressing MODE button.



B) Turn the RF CONTROL dial to set up temperature while '\*SET TEMP' is displayed on digital display. Temperature is displayed on front display of the generator.



C) Press the RF POWER control dial to indicates '\*set watt' on the digital display and turn the RF POWER control dial to set RF POWER output.

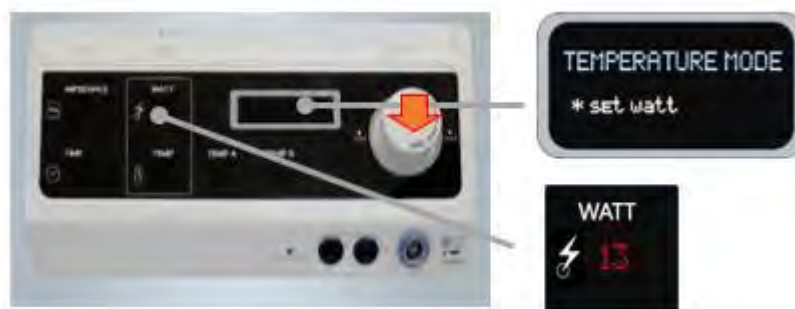

D) Press the RF POWER control dial to indicates '\*set time' on the digital display. Turn the RF POWER control dial to set time.



E) RF POWER output is started with light up on RF START/STOP button if it is pressed.

F) Temperature of procedure target is able to be monitored by temperature monitoring channel.

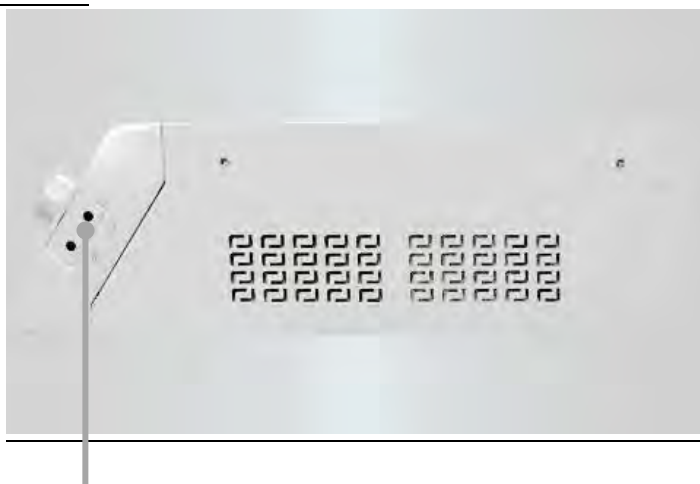

Temperature sensor connector

### **(5) Measuring Impedance**

A) Holding down OHM CHECK button to check impedance value displays on left side with light up on the button and if the button is released, it comes back to standby with light off



**Note** : read the user's guide for this equipment prior to the treatment and use the equipment afterwards.

## A. Operation and storage of PC linked monitor program



No.	Feature name	Function
1	Start monitoring	Connect or disconnect the USB Serial communication between your PC and RF Generator.
2	Path	Select a folder which the log files will be saved to.
3	ID	To set an ID
4	Auto/Manual Stop	Indicates the monitoring status of the output's data
5	Setting Icon	Set the display configuration that you would like displayed
6	RF Output Graph	Display graph and output value measured from the active tip of the electrode at the time of RF output
7	TIME	Indicates the lap time for a RF ablation.
8	RF Output Value	Indicates output value measured on the active tip of the electrode at the time of RF output



- 1) Connect the generator to a computer that has the monitoring viewer program installed by using a cable that can carry out the USB communication.

**Caution:** Connect the generator to the computer that has the software installed before running the software via USB communication cable.

- 2) Start the program by double clicking the 'MRFALogger' shortcut icon or MRFALogger.exe in the folder of the path where the software is installed.



- 3) Use the computer to find the communication port setting for the communication between the generator and computer (sequence: Diagram 1 → 2 → 3). Click on the indicated menu to view the devices as shown in Diagram 1. Select the device that is being used. Check the current communication port by clicking on the port (COM and LPT) among the indicated device list.

(Example: COM1 or COM2 or USB Serial Port [COM5])

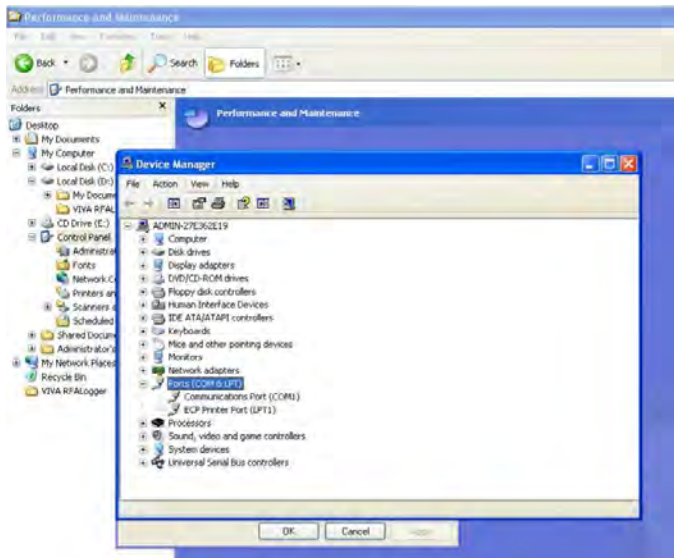

**Diagram 1**

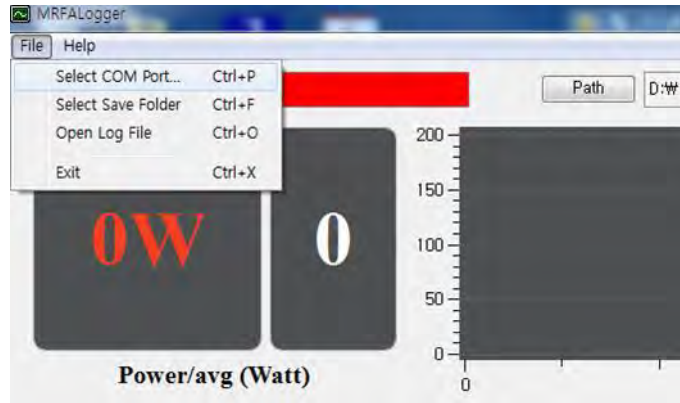

**Diagram 2**

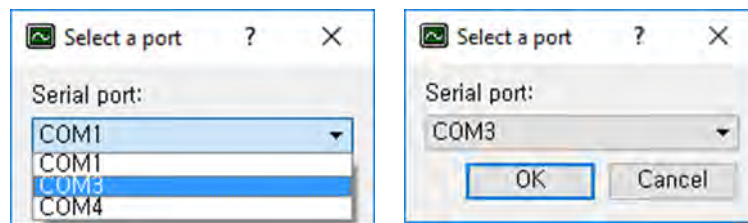

**Diagram 3**

⚠ Caution: USB communication may be disconnected depending on your PC. In that case, set the USB communication port again.

#### 4) USB Serial Port

Select and execute the port menu to set up the communication port that is currently in use.

Click 'Start monitoring' or File – Select COM Port to activate the monitoring viewer program.

The background color of the USB port box will change to green after completion.

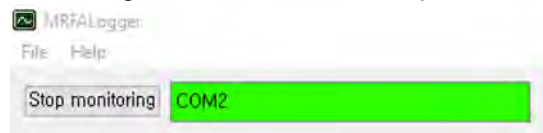

The background color will change to red when the USB cable is disconnected or the "Stop Monitoring" button is clicked.

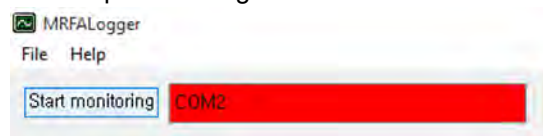

If the message shows "No Port," the "Select a Port" dialog box will be automatically displayed to select the USB serial port.



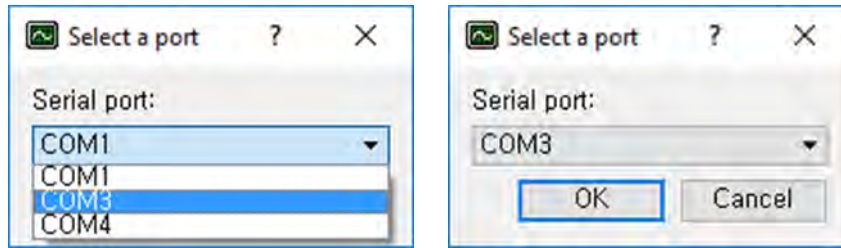

In the “Serial port” drop-down box, select the USB serial port number in use for the viewer program. Press “OK” to connect the USB serial communication between the PC and RF Generator. Press the “Start Monitoring” button again to prepare for usage.

If you do not know which port you should choose, open up a Device Manager of your computer to find out lowest USB serial port number and select the port number in the “Serial port” drop-down box.

#### 5) Path



Choose “Select Save Folder” under the “File” menu or click the “Path” button. Select the folder to store the log files that are created automatically for every RF Generator operation. Each file name is saved in the following format:

‘week\_month\_day\_hour\_minute\_second\_year\_record.txt.’  
(example: Fri\_Jan\_09\_19H\_14M\_01S\_2015\_record.txt)

If the ID is set, the log file’s name is extended with the ID. The file name is saved in the following format:

‘ID\_week\_month\_day\_hour\_minute\_second\_year\_record.txt.’  
(example: STARmed\_Fri\_Jan\_09\_19H\_14M\_01S\_2015\_record.txt)

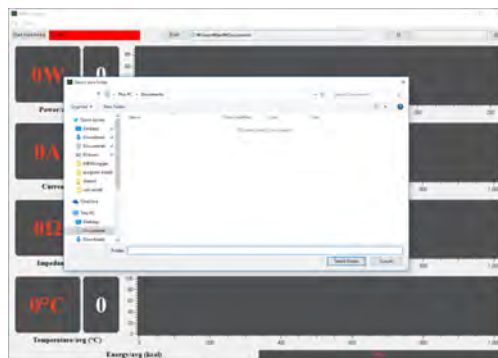

Select “Choose” to select the folder to save to. The address box will be updated automatically.

#### 6) ID

You may need to specify the log file’s name to distinguish each patient’s information.

Click the “ID” button and Input the characters.

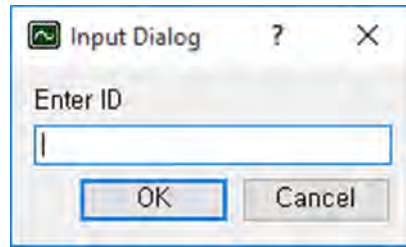

If the ID is set, the log file's name will be extended with the ID. Each file name format is assigned below.

- 'ID\_week\_month\_day\_hour\_minute\_second\_year\_record.txt'
- (example : STARmed\_Fri\_Jan\_09\_19H\_14M\_01S\_2015\_record.txt)

## 7) Display Configuration

Set the Display Configuration to the desired display.

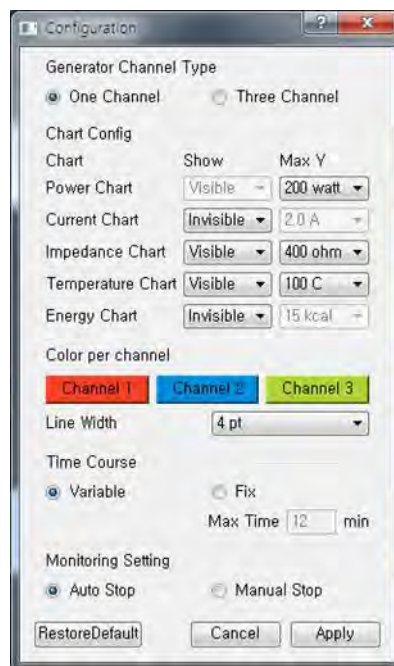

### (1) Generator Channel Type :

- One Channel : The display for only one channel electrode generator.
- Three Channel : The display for three channel electrode generator.

### (2) Chart Config :

- Show : Selection of the display for each parameter
- Max Y : Adjustment of the amplitude for each parameter

### (3) Color per Channel : Set the colors of output value and the line of graph.

- Line Width : Set the line width of the graph.

### (4) Time Course :

- Variable : Set to enable automatic time axis resizing.
- Fix : Set the time axis limit range from 1 to 99

### (5) Monitoring Setting :

- Auto Stop : Redraw the graph every time the RF output starts.
- Manual Stop : Continuously draw the graph even if RF output restarts.

### (6) Restore Default : To choose the default setting.

### (7) Cancel : Escape without setting.

### (8) Apply : Apply user setting.

## **B. Installing and running of monitoring software on tablet PC (VIVALogger)**

### 1) Installing APPLICATION (for Android only)

Before install the APPLICATION on a tablet PC, make sure that third-party applications are allowed on the device. Go to Menu > Setting > Security > and check 'Unknown Sources' to make the tablet PC allows to install the application.

- a) Download the VIVALogger\_Version.apk file on the PC and then transfer the file to the tablet PC.
- b) Open VIVALogger\_Version.APK to install on the tablet PC.
- c) The APPLICATION will be installed on the tablet PC.

### 2) Usage

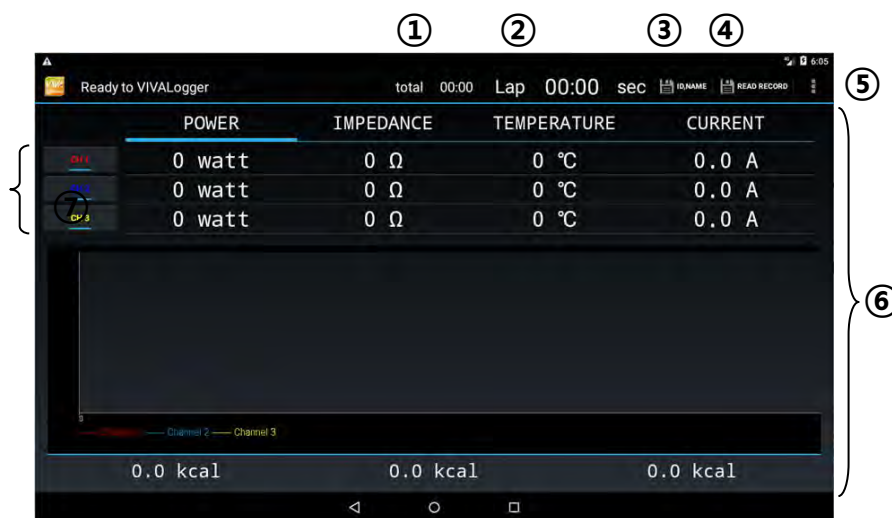

- ① total: Indicates the total time for a procedure.
- ② Lap: Indicates the lap time of the RF ablation.
- ③ ID, NAME: User may need to specify the log file name to distinguish each of the patient information.  
Each file name is saved in the following format:  
'name@week\_month\_day\_hour\_minuate\_second\_year\_record.txt' format  
▶ name@Wed\_Mar\_16\_11H\_32M\_30S\_2016\_record.txt  
The 'READ RECORD' provides the file list.
- ④ READ RECORD: To recall the log file data that has been saved previously, it allows user to recall saved data.

- ⑤ Configuration  :
- Setting Serial: Bluetooth setting

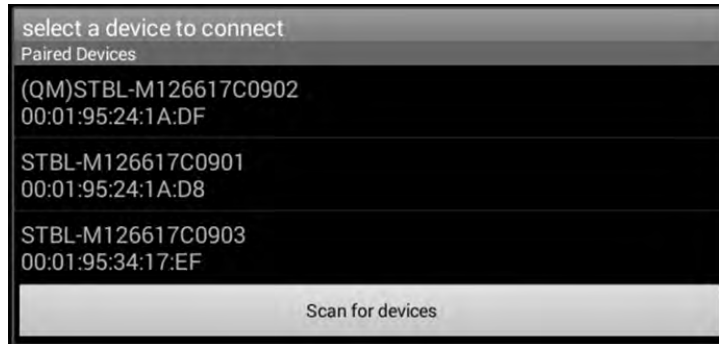

'Scan for devices' retrieves already discovered or known devices that are nearby.

Select a Bluetooth device to connect to the tablet PC.

Enter the correct code (Default pairing code: 1234) and there will be a notification if the Bluetooth connection has successfully paired with the tablet PC.

- Write Info: Write information
  - About: Display version of VIVALogger
  - Quit: Exit of the APPLICATION
- ⑥ POWER, IMPEDANCE, TEMPERATURE, CURRENT: Displays the RF graph of selected RF Parameter.
- ⑦ CH1, CH2, CH3: Determine whether each selected channel is visible or not.
- 3) Move log files by USB  
Log files can be transferred between the computer and the tablet PC via USB cable.  
On the tablet PC, tab the 'USB for ..' notification.  
On the PC, open File Explorer. and search for the Android device  
Look for the 'VIVA' folder in internal storage of the Tablet PC.  
The log files in the 'VIVA' folder can be dragged and dropped between the PC and Tablet PC.
- 4) Tablet PC Minimum specification  
 Screen 7 ~ 10 inches of screen Android Froyo 2.2 or later version.

### C. Foot switch installation and operations guide

☞ Foot switch is an optional product accessory.

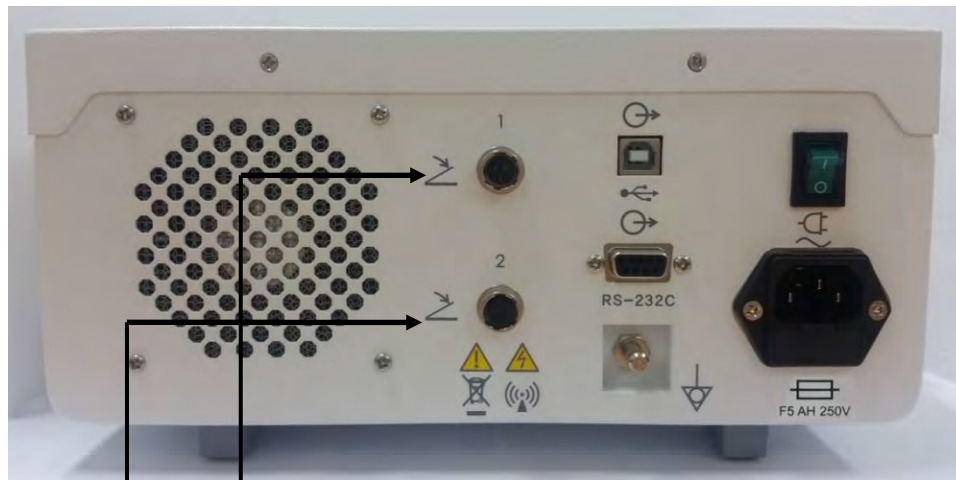

Single Foot Switch



Double Foot Switch

**Note :** Connect the foot switch as the image above, then tighten the screws.

A) Single Foot Switch.



The single foot switch pedal operates same function as the RF START/STOP button function.

**Note:** Press the RF START/STOP button for more than 1 second to activate the RF output.



The Single foot switch has the same function as the RF START/STOP Button

B) Double Foot Switch.



The double foot switch pedals operate same function as the RF POWER control dial function

Press the Yellow pedal to reduce RF POWER output by -5W.  
(Pressing and holding the pedal decreases RF POWER output quickly.)

Press the Blue pedal to increase RF POWER output by +5W.  
(Pressing and holding the pedal increases RF POWER output quickly.)



The double foot switch has the same function as the RF POWER control dial on the front panel.



## Labeling & Packaging

### Labeling

#### 1) VIVA combo RF Generator (Box, product label)



#### 2) VIVA PUMP (Box, product label)

##### ■ VP01

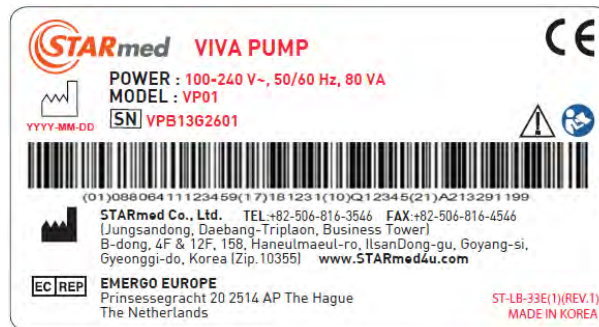

##### ■ VP01-1

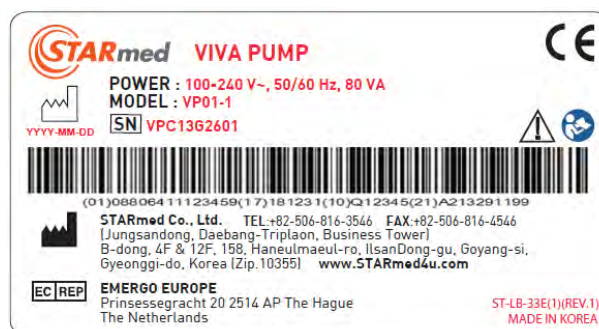

### Packaging

Type of packaging : Corrugated cardboard box

Mass of packaging : 1.5 kg







## Explanation of symbols

### RF generator

Symbol	Meaning
	DEFIBRILLATION-PROOF TYPE BF APPLIED PART
	Floating return (high frequency)
	Warning, electricity
	General warning sign
	EC representative
	Footswitch input jack
	Signal input/output port
	Refer to instruction manual/booklet
	Equipotentiality
	Indicates rotational direction of increase (for output control and set output)
	RF START /STOP
	Non-ionizing electromagnetic radiation
	Serial number
	Manufacturer
	Date of manufacturer
	Power on
	Power off

## Box

Symbol	Meaning
	<p>To indicate that the transport package shall be kept away from rain and in dry conditions.</p>
	<p>To indicate that hooks shall not be used for handling the transport package.</p>
	<p>To indicate correct upright position of the transport package.</p>
	<p>To indicate that the contents of the transport package are fragile and the package shall be handled with care</p>
	<p>To indicate that the items shall not be vertically stacked beyond the specified number, either because of the nature of the transport packaging or because of the nature of the items themselves.</p>

## Generator output power characterization

### (1) CONTINUANCE MODE

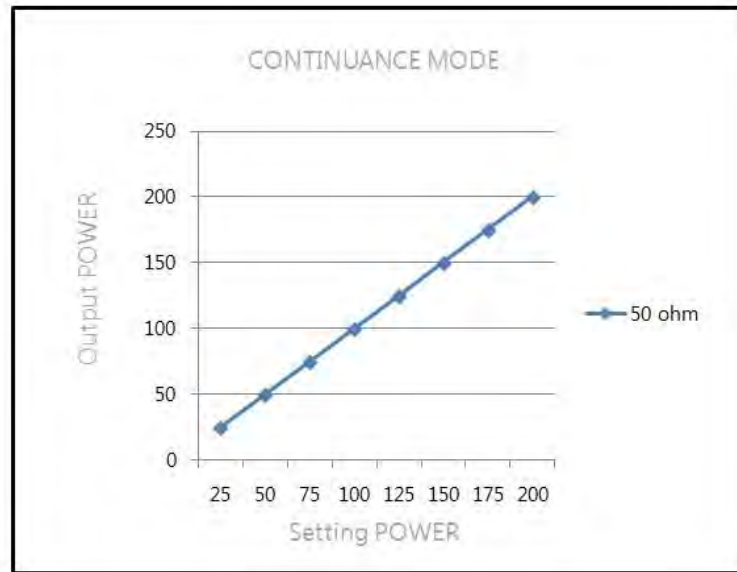

### (2) GENERAL MODE

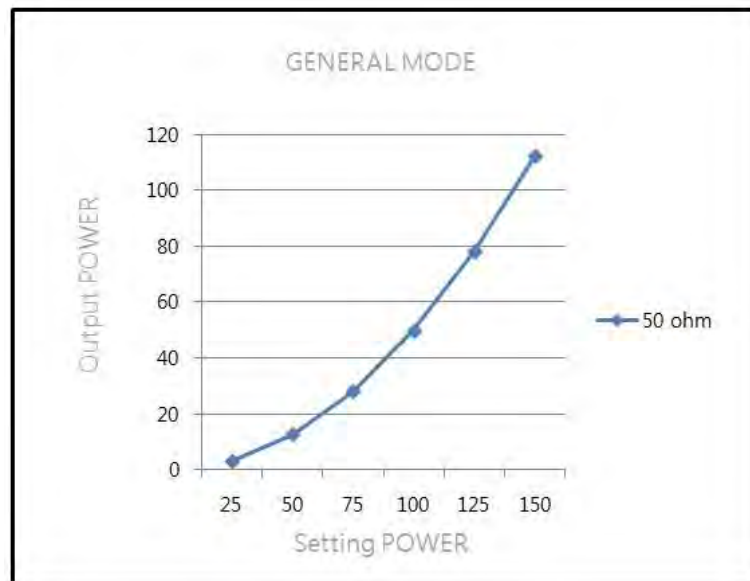

\* For more information about the RF power, refer to the service manual

## Diagram of power output data

(1) 150W (maximum output current :2A)

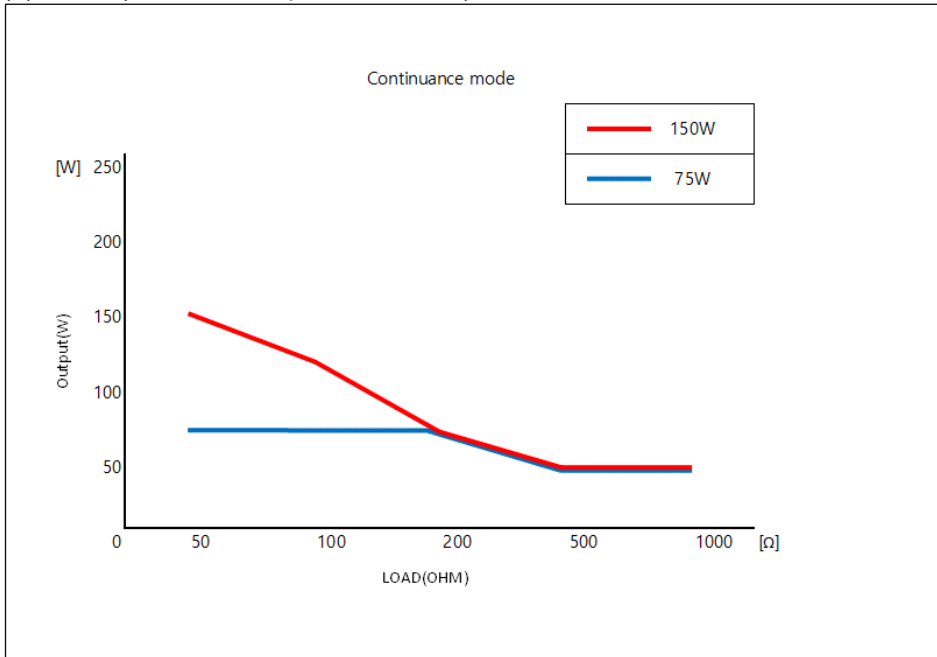

(2) 200W(maximum output current :2A)

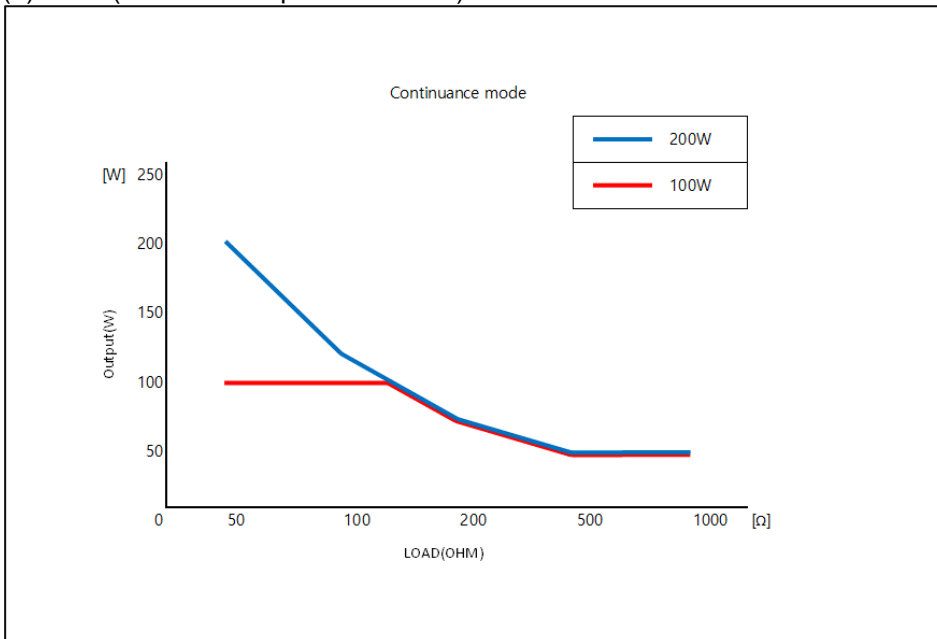

## Radiofrequency lesion generator specifications

Rated power	
Voltage range:	100 - 240 V~
Maximum input power:	450 VA
Fuse capacity:	F5 AH 250V
Power frequency:	50/60 Hz
Impedance measurement	
Range:	10 - 800 ohms
Resolution:	1 ohm
Accuracy:	10 - 50 ohms $\pm 10$ ohm
	51 - 300 ohms $\pm 15\%$
	301 - 800 ohms $\pm 30\%$
radiofrequency output	
Watts:	0 - 200 watts max output @ 50 ohm
Accuracy:	$\pm 20\%$
Resolution:	1 watt
Frequency:	480 kHz $\pm 10\%$
Drive on time:	30minutes max.
temperature measurement	
Range:	5°C - 95°C
Resolution:	1°C
Accuracy:	$\pm 5^\circ\text{C}$
Operating environment	
Clean, dry area	
Temperature	15°C - 40°C
Humidity:	15 - 80% relative, non-condensing
Atmospheric Pressure:	800 - 1060 hPa

## 3. Peristaltic pump

**Caution**

Use this Peristaltic pump only after reading the warnings, cautions, and information on the product's usage.

Use other accessories related to the peristaltic pump only after reading the warnings, cautions, and information on the product's usage.

## Description

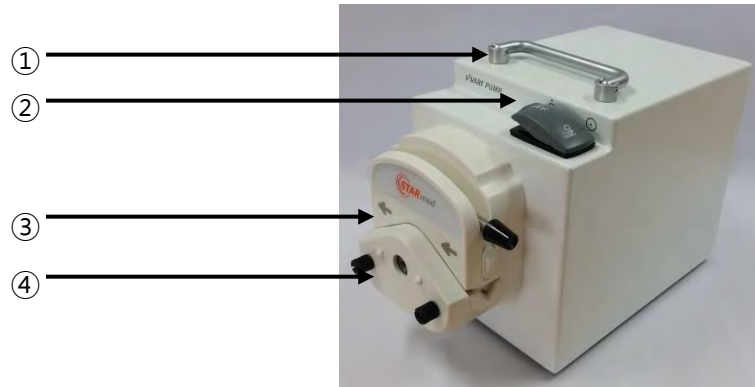

### VP01

#### *Description of the pump front part and control part*

No.	Feature name	Function
1	Handle	Handle that use for moving of pump
2	Power Switch	Switch that starts and stops the operation of the pump roller
3	Tube compression lever	Maintains proper contact status between the pump tubing and roller Clamps that are located at the two sides fix the location of tubing
4	Roller head	Body of revolution composed of the rollers that press down on the pump tubing to push and squeeze out the coolant

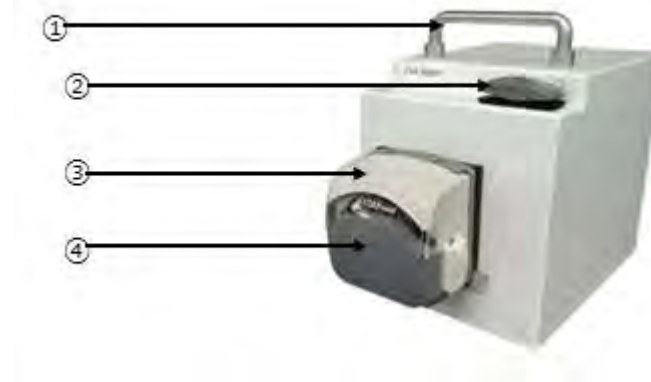

### VP01-1

#### *Description of the pump front part and control part*

No.	Feature name	Function
1	Handle	Handle that use for moving of pump
2	Power Switch	Switch that starts and stops the operation of the pump roller
3	Flip cover	Maintains proper contact between the pump's tubing and roller Clamps that are located on the two sides that are used to fix the location of tubing
4	Roller head	Includes the rollers that press down on the pump's tubing to circulate the coolant.

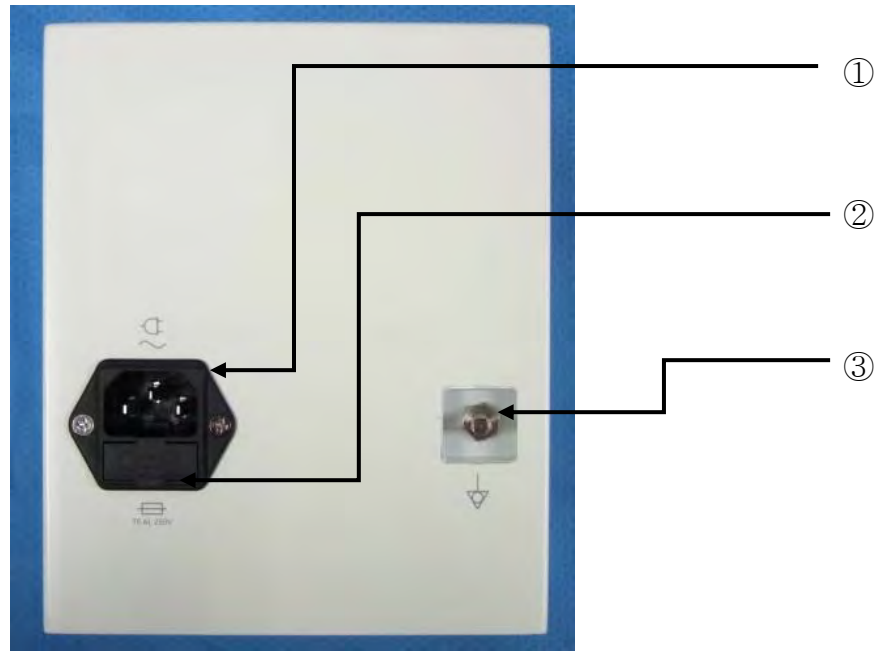

*Description of the pump's rear part[VP01,VP01-1]*

No.	Feature name	Function
1	MAINS INLET	AC Power cable coupler
2	FUSE box	Two fuses attached
3	EQUIPOTENTIAL GROUND	Equipotential coupler for making the equipment besides the main frame and the electric potential, the same



## Preparations

### Mounting the pump tubing inside of the front part(VP01)

Lift up the cover by pushing the TUBE COMPRESSION LEVER to the left.

Mount the tubing to the inner side of the roller head. When mounting, mount the tubing by lifting up the TUBE AUTOMATIC CLAMP.

Lift down the roller head cover by pushing the TUBE COMPRESSION LEVER to the right side to the very end, 180° and check the tube fixation status.

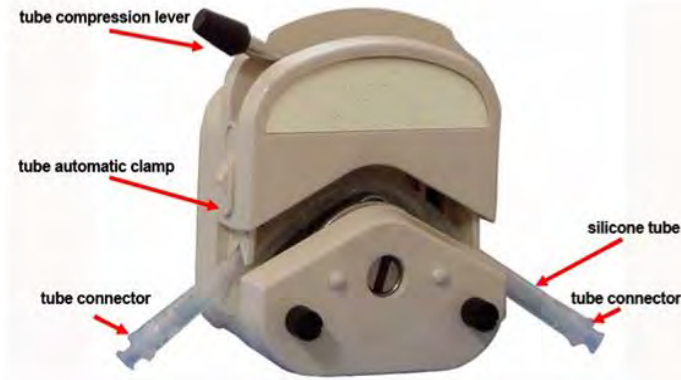

### Mounting the pump tubing inside of the front part (VP01-1)

Flip the cover upwards. Place the pump's tubing in the roller located inside the pump's head. Flip the cover down and check that the tubing is secure.



#### Caution

Use the sterilization pump tubing provided in the electrode set.

To prevent contamination, do not reuse disposable pump tubing after using it.

## Explanation of symbols

	Caution
	Equipotentiality

## Peristaltic pump specifications

Rated power	
Input voltage	100 - 240 V~
Frequency	50/60 Hz
Consumption power	80 VA (max.)
Flow rate (when using while connecting to the electrode tubing set)	
Flow rate :	load = 80ml or higher (no load = 120 ml or higher)
Dimension	
Size ( w x h x d )	193 * 160 * 135 mm
Weight	4 Kg
Operating Environment	
Clean, dry area	
Temperature:	15°C - 40°C
Humidity:	15 - 80% relative, non-condensing
Atmospheric Pressure:	800 - 1060 hPa

## 4. Others

### Caution

Use generator only after reading warning and caution messages and information on the usage first.

Use other accessories related to this generator only after reading information on the usage, and warning and cautioning messages first. The guide related to electrode is provided separately.

## Device Classification

Classification as per EN 60601-1, the manufacturer describes the VIVA combo RF generator as:

Type of protection against electric shock:	class I
Degree of protection against electric shock:	Generator → Type BF Defibrillator Protected Pump → Not applicable
Degree of harmful ingress of water:	IPX 0
Mode of operation:	<u>Non-continuous(on: 10 s / off: 30 s)</u>
Degree of safety in the presence of flammable anesthetic mixture with air, oxygen or nitrous oxide:	Not suitable for use

## Storage and management after use

- Management method after using the generator (PC for monitoring viewer)

A) Turn off the power switch of the generator's rear panel and separate the accessories from it.

B) Separate the power code from the power outlet on the wall.

C) To store, keep the proper temperate from 10 - 40°C.

D) Cleaning method: Use 70% isopropyl alcohol solution to wipe off the generator's panel. However, there should be no moisture remaining in the electrode coupler.

- Storing method

A) Store it in the place that is free from the effects of the atmosphere that includes air pressure, temperature, humidity level, wind, sunlight, salinity, ion etc.

B) Be careful to ensure safety against vibration, shock etc. (at the time of transport, and move)

C) Do not store at the place where chemicals are stored, or where gas might be generated.

D) Do not store it at the place where is close to the water.

E) Gather together the accessories such as code and connectors after cleaning them well.

### Transportation and Storage Environment

Clean, dry area

Temperature : -40°C - 40°C

Humidity: 0% - 87%, including condensation

Atmospheric Pressure: 800 - 1 060 hPa

## Equipment waste and management



- Discard  
Please call or Consult your local STARmed representative for supporting.
- This product can only be treated or disposed of in facilities with the appropriate authorisations (waste management licences / permits)
- This product does not use of components and parts that contain stored energy or pose other HAZARDS that can result in an unacceptable RISK to disassemblers or others.
- This product does not use of HAZARDOUS SUBSTANCES requiring special handling and treatment.
- This product does not use of HAZARDOUS SUBSTANCES including radioactive sources and not induced radioactive materials

## Cleaning and Disinfection

The RF Lesion generator for tissue ablation during surgical procedures with coagulation electrode's reusable components may be cleaned with mild cleaning solutions, such as 70% isopropyl alcohol. Care should be taken to keep moisture out of the connectors. Store both units and accessories in a clean, dry, and non-corrosive atmosphere. The generator, pump, and accessories are designed to withstand all normally encountered environmental conditions (see "RF Generator Specifications" and "Pump Specifications").

The coagulation electrode kits are for SINGLE USE ONLY. Do not clean or re-sterilize products prior to use. Do not attempt to reuse coagulation electrodes and grounding pads.

### Caution

Do not sterilize RF Lesion generator for tissue ablation during surgical procedures or pump. Sterilization will destroy the unit's electronic components.

## Maintenance and Service

The RF lesion generator and pump are not user serviceable, and both units should be returned to STARmed authorized service center if any problems arise. To ensure accuracy of unit outputs and displays, the annual inspection of the unit is recommended by official process. Please call your local STARmed representative for support in detail.

This equipment has been tested and found to comply with the limits for medical devices in IEC 60601-1-2. These limits are designed to provide reasonable protection against harmful interference in a typical medical installation.

The RF Lesion generator for tissue ablation during surgical procedures is designed to be durable medical equipment. However, physical impact, such as dropping the unit, may result in damage and subsequent injury to the patient or operator. If the generator or pump is subjected to impact, discontinue use and immediately return the generator or pump to STARmed for evaluation.

The pump generates uses and can radiate radio frequency energy and, if not installed and used in accordance with the instructions, may cause harmful interference to other devices in the vicinity. However, there is no guarantee that interference will not occur in a particular installation.

If this equipment does not cause harmful interference to other devices, which can be determined by turning the equipment off and on, the user is encouraged to try to correct the interference by one or more of the following measures:

Reorient or relocate the receiving devices.

Increase the separation between the equipment.

Connect the equipment into an outlet on a circuit different from that to which the other device(s) are connected.

Consult the manufacturer or field service technician for help.

### Caution

You must replace the tubing sets with each patient use.

Remove tubing after each coagulation RF electrode procedure to minimize risks and to prevent contamination

RF Generator check is must be maintained by qualified and trained personnel.

## Other matters

- A. Product name: Radiofrequency lesion generator (Class IIb by CE classification)  
Brand name : VIVA combo RF Generator  
Model name: VCS10
- B. Manufacturer's business name: STARmed Co.,Ltd  
Manufacturer's address: (Jungsan-dong, Daebang-Triplaon Business Tower), B-dong,  
4F & 12F, 158, Haneulmaeul-ro, Ilsandong-gu, Goyang-si, Gyeonggi-do, Korea
- C. Purpose for the product use: Medical device that is used for the necrosis coagulation of  
the targeted tissue or for hemostasis by using radiofrequency current
- D. Manufacture No. and date of manufacture: refer to the label
- E. Weight: 6 kg      Packing unit: 1 set
- F. Performance and use method: refer to the user's guide
- G. Cautions during use: refer to the user's guide
- H. Other matters to be included
  - (1) Rated power: 100 - 240 V~
  - (2) Frequency: 50/60 Hz
  - (3) Consumption power: 450 VA
  - (4) Rated output: 0 - 200W(50Ω), 480 kHz
  - (5) Format and degree of protection against electric shock: Class 1, Type BF applied part
- I. Attached part: product's exterior decor
- J. This product is a medical device

### Caution

Do not sterilize radiofrequency lesion generator or peristaltic pump. If do, it may  
a cause of damage of the devices.